

TCL JUNIOR - TCL JUNIOR SUPER



 max 4 cm



VIDEO

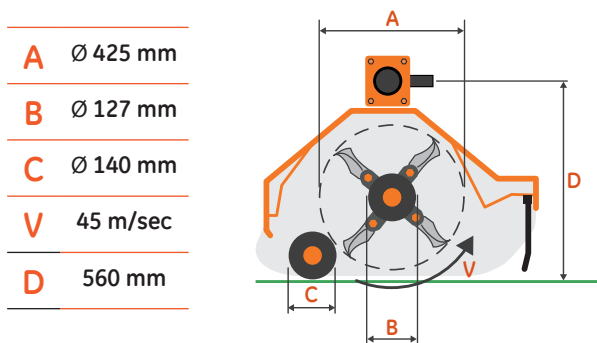





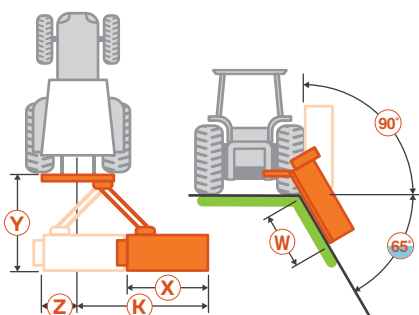

Dotazioni di serie

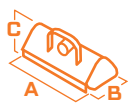
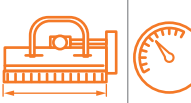
- Attacco al trattore Cat.2
- Trasmissione a bagno d'olio con ruota libera
- Piedini di appoggio
- Cuscinetti rotore a doppia sfera oscillante
- Rotore bilanciato elettronicamente
- Rullo di appoggio regolabile (autopulente o con raschia-rullo)
- Giunto cardanico
- Protezione Carter

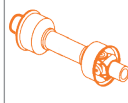

	X	Y	Z	K	W
	cm	cm	cm	cm	cm
TCL JUNIOR 140	135	145	63	212	127
TCL JUNIOR 160	153	145	63	230	147
TCL JUNIOR 180	172	145	63	249	167
TCL JUNIOR Super 140	135	171	39	236	138
TCL JUNIOR Super 160	153	171	39	254	158
TCL JUNIOR Super 180	172	171	39	273	178

										
	A - B - C (mm)	mm - inch	G/min	HP	kg	Cat	N°	kg	N°	N°
TCL JUNIOR 140	1611-1450-1000	1433 - 56	540	50	1500	5	3	457	40	20
TCL JUNIOR 160	1763-1450-1000	1585 - 62	540	60	2000	5	3	469	44	22
TCL JUNIOR 180	2023-1450-1000	1845 - 72	540	70	2000	5	4	510	52	26
TCL JUNIOR Super 140	1795-1450-1000	1433 - 56	540	50	1500	5	3	457	40	20
TCL JUNIOR Super 160	1947-1450-1000	1585 - 62	540	60	2000	5	3	469	44	22
TCL JUNIOR Super 180	2207-1450- 1000	1845 - 72	540	70	2000	5	4	510	52	26

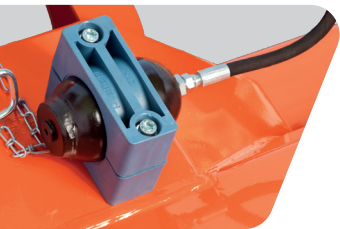

Optional
 Trinciatrice autolivellante al terreno
 Self-leveling on the ground flail mower
 Mulcher mit Selbstniveauregulierung zum Boden
 Broyeur auto nivellement au terrain
 Trituradoras autonivelantes al suelo

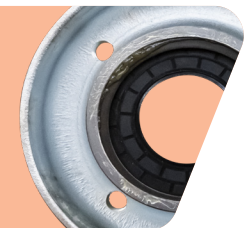

Supporti rotore in fusione monoblocco
 Rotor supports in monobloc casting
 Giessen Teile
 Supports rotor en coulée monobloc
 Piezas únicas de fundición

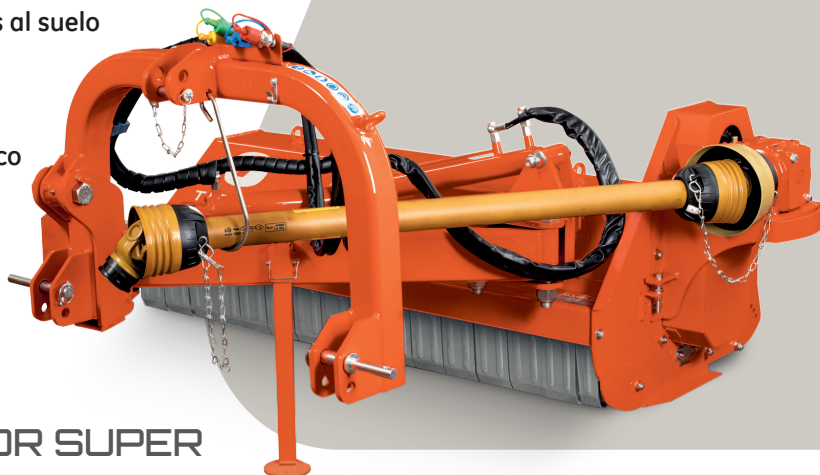

TCL JUNIOR SUPER

Standard equipment

- Tractor linkage Cat.2
- Oil sealed transmission with free wheel
- Rest
- Rotor bearings with double oscillating sphere
- Electronically balanced rotor
- Adjustable in-high roller (self-cleaning or with scraper)
- P.T.O. shaft
- Protecting carter

Équipement de série

- Attelage tracteur Cat.2
- Transmission bain d'huile avec roue libre
- Pieds d'appui
- Roulements rotor à double sphère oscillante
- Rotor équilibré électroniquement
- Rouleau d'appui avec décrottoir réglable en hauteur
- Cardan
- Protection carter

Rullo regolabile - Adjustable roller

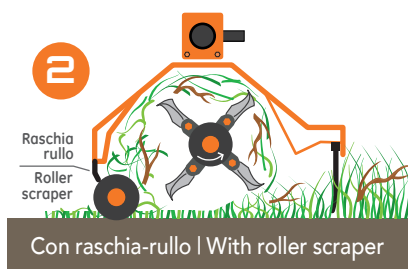

Standardausstattung

- Traktoranbau Kat.2
- Ölbad-Getriebe mit Freilauf
- Stützfüße
- Rotor Lagerung mit zweireihigen Pendelrollenlagern
- Rotor elektronisch ausgewuchtet
- Selbstreinigende, verstellbare Stützwalze mit Erdkratzer
- Gelenkwelle
- bessere Bodenanpassung durch schwenkbaren Anbaubock
- Keilriemenschutz

Equipamiento estándar

- Conexión Cat. 2
- Transmisión con rueda libre
- Apoyos
- Rodamientos oscilantes de bolas doble (rotor)
- Rotor balanceado electronicamente
- Rodillo de apoyo con raspador ajustable
- Junto cardán
- Protección carter



Mazza doppio tagliente
 Double cutting hammer
 Doppelschnitt Hammerschlägel
 Marteau à double tranchant
 Martillo de doble corte

Optional



Ruota anti-intasamento
 Anti-obstruction wheel
 Antiverstopfrad
 Roue anti-engouffrement
 Rueda anti bloqueo

TCL JUNIOR - TCL JUNIOR SUPER